



Domestic Air Conditioner

SERVICE MANUAL

MODEL:

HPU-24C03/VA(ZXF)

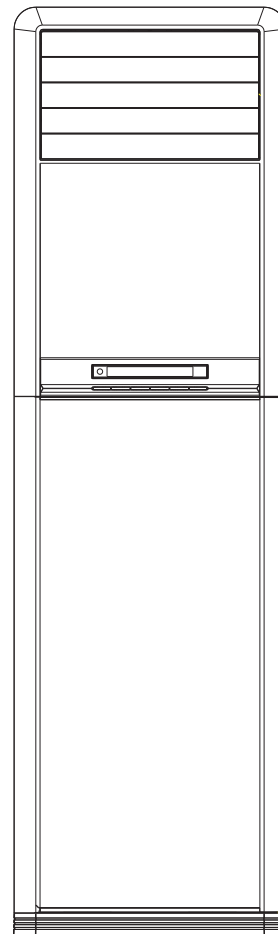

- **Features**

- Highly efficient and energy saving.
- 15-meter long-distance airflow. □
- High luminous LED display technology. □ □
- Powerful operation, fast temperature adjusting.

Edition: 2005-12-12



Большая библиотека технической документации

<https://splitsystema48.ru/instrukcii-po-ekspluatácii-kondicionerov.html>

каталоги, инструкции, сервисные мануалы, схемы.

Content

1. Description of product model coding and series introduction	3
2. Specifications	5
3. Description, net dimensions and functions of main components and accessories	7
4. Brief introduction to electrical control functions	15
5. Wiring diagram	20
6. Circuit diagram	22
7. Abnormity diagnose	24
8. Trouble shooting	26
9. Refrigerating cycle diagram	28
10. Noise level test chart and air velocity distribution	30
11. Installation manual	33

Features

1. comfortable:wide-angle airflow

The vertical dual-flap and horizontal wide-angle louvers ensure the cool(warm air reaches every corner of the room.

2. Health air purifying

An air purifying filter with deodorizing and disinfecting functions keep the air clean and users healthy.

3. Quiet operation

Fan With Random-pitched Blades.

Random-pitched blades help reduce operating noise while maintaining a high airflow rate.

4. Energy efficient

The design of inner-grooved copper tube greatly increases the refrigerant contact area and the efficiency of cooling/heating functions.

5. Convenience

Auto restart and washable panel:

The grille can be removed easily and washed when necessary. Any series have the function then even if the power falls when the unit is operating unit will automatically return to the operating settings in use before the power failure when power is restored.

6. Wide variety of functions

24-Hour Timer:

24-hour timer allows users to select the exact time they would like the air conditioner to turn on and to turn off. Timers on previous models operation based on the number of hours of desired operation.

7. Night-set models

When the air conditioner is operating on the timer-off circuit. The preset room temperature gradually rises (going down in heating) before the unit stops as shown below. Users can sleep comfortably without sudden change in temperature.

8. Program "dry"

This function automatically reduces the level of humidity while maintaining the preset indoor temperature.

Description of product model coding and series introduction

Introductory Remarks

A. Description of coding rules of unit model

Coding rules and descriptions are as follows:

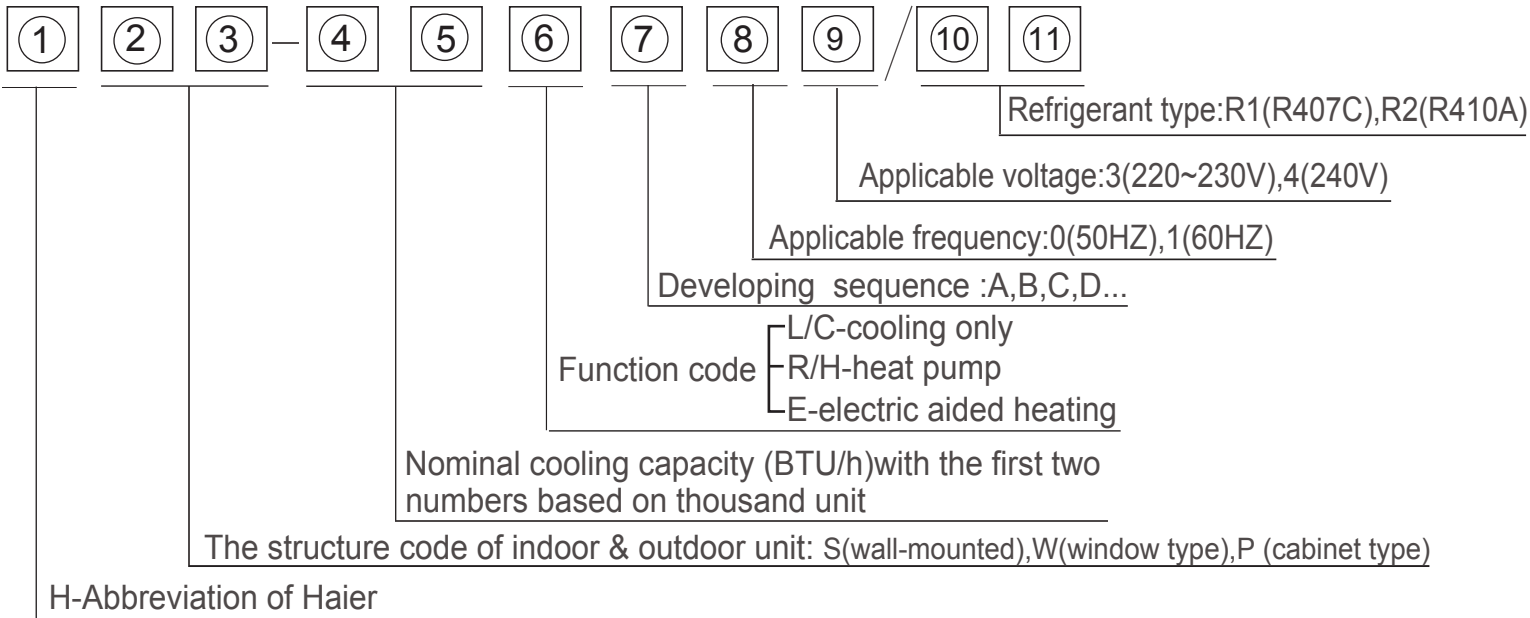

Examples:

HPU-24C03/VA(ZXF),It represents cabinet split type cooling pump air conditioner .The cooling capacity is 24000BTU/h,and the power supply is 220V/50Hz, and the refrigerant is R22.

B.Standard Situation/Conditions

No.	Operating condition	indoor air status		outdoor air status	
		DB ^o C	WB ^o C	DB ^o C	WB ^o C
1	Norminal cooling	27 ^o C	19 ^o C	35 ^o C	24 ^o C
2	Norminal heating	20 ^o C	not control	7 ^o C	6 ^o C
3	Norminal electrical heating	---	---	---	---

Specifications

Model: HPU-24C03/VA(ZXF)

Cooling capacity(W)	7100	Heating capacity(W)	——
Cooling coefficient(W/W)	2.73	Heating coefficient(W/W)	——
Cooling power input(W)	2600	Heating power input(W)	——
Moiture removal(m ³ /h)	4.19X10 ⁻³	Frequency range(Hz)	50
Operating voltage range(V)	220V	Refrigerant type	R22
Operating temp. range (°C)	18~43	Air sending angle	60°
Variation of temp. adjust (°C)	+ 1	Fan type	indoor unit
			outdoor unit
Climate type:	T1	Class of electric shock	I
Indoor unit noise	50/44/38	Outdoor unit noise	58
Net dimensions mm (indoor unit)	510*320*1793	Net dimensions mm (outdoor unit)	860*308*730
Packaging dimensions mm (indoor unit)	625*395*1930	Packaging dimensions mm (outdoor unit)	995*420*805
Net/gross weight (kg) (indoor unit)	48/63	Net/gross weight (kg) (outdoor unit)	53/68
Max. mounting height difference(m)	10	Piling layers	indoor unit
			outdoor unit
Refrigerant charge(g) (R22)	2300	Current entering side (indoor/outdoor)	Indoor
Frequency of filter cleaning	Once/2 weeks	Compressor manufacturer	HITACH
Compressor model	THU33WC6-U	Compressor oil type	SUNISO 4GSD
Compressor oil charge (ml)	480	Compressor protector type	INSIDE
Maxi. length of connecting pipe (m)	15	drain hose	length(mm)
Refrigerant recharged(Length of connecting pipe is more than 5 meter)	18g per meter		diametre(mm)
Cap. tube type muffle model:	TP ₂ Y	Type of tube of evaporator and condenser	Internal treaded
Fan speed(H/M/L)(r/min) (indoor unit)	530/480/360	Size of tube of evaporator and condenser(mm)	Dia. 7 / 7
Fan speed(r/min) (outdoor unit)	1050	Appearance features of indoor unit	Horizontal grill
Cut-off vavle(inch)	two-way	Appearance features of outdoor unit	Iron casing
	three-way		
Max. operating pressure at warm side(Mpa)	2.65	Max. operating pressure at cool side(Mpa)	0.65

Description, dimension and function of main components and accessories

Parts and Functions

Indoor unit

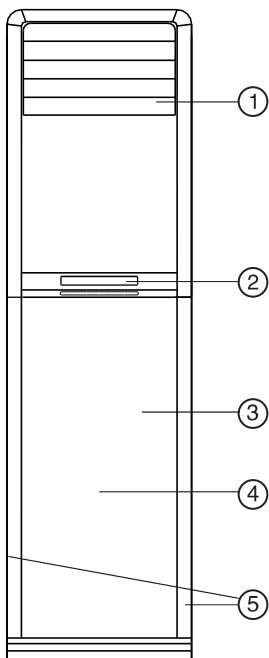

- 1.OUTLET
- 2.CONTROL PANEL
- 3.INLET GRILLE
- 4.AIR FILTER(inside)
- 5.INLET

Outdoor unit

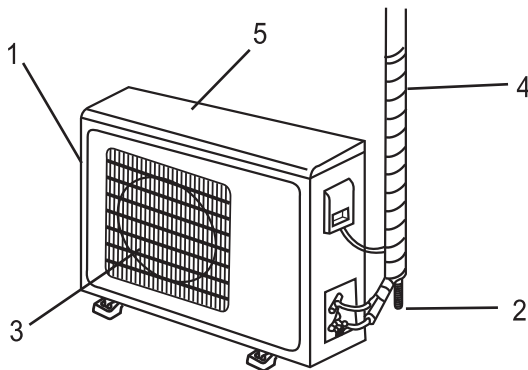

- 1.INLET
- 2.DRAIN HOSE
- 3.OUTLET
- 4.CONNECTING PIPING AND ELECTRICAL WIRING
- 5.INLET

Net dimensions for indoor unit

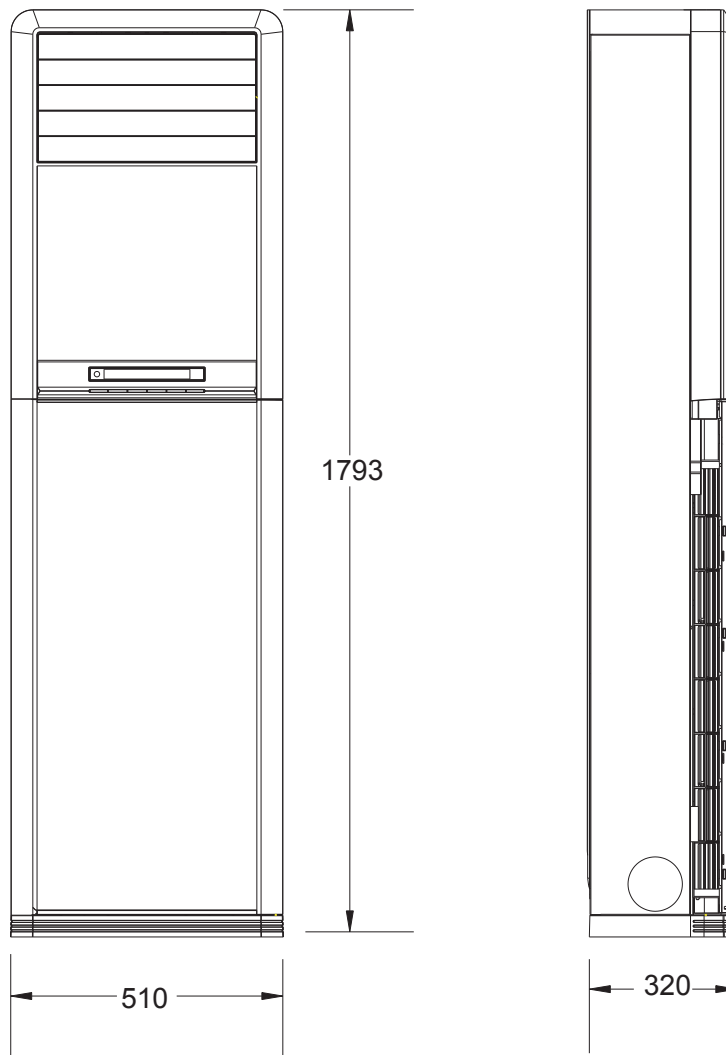

Net dimensions for outdoor unit

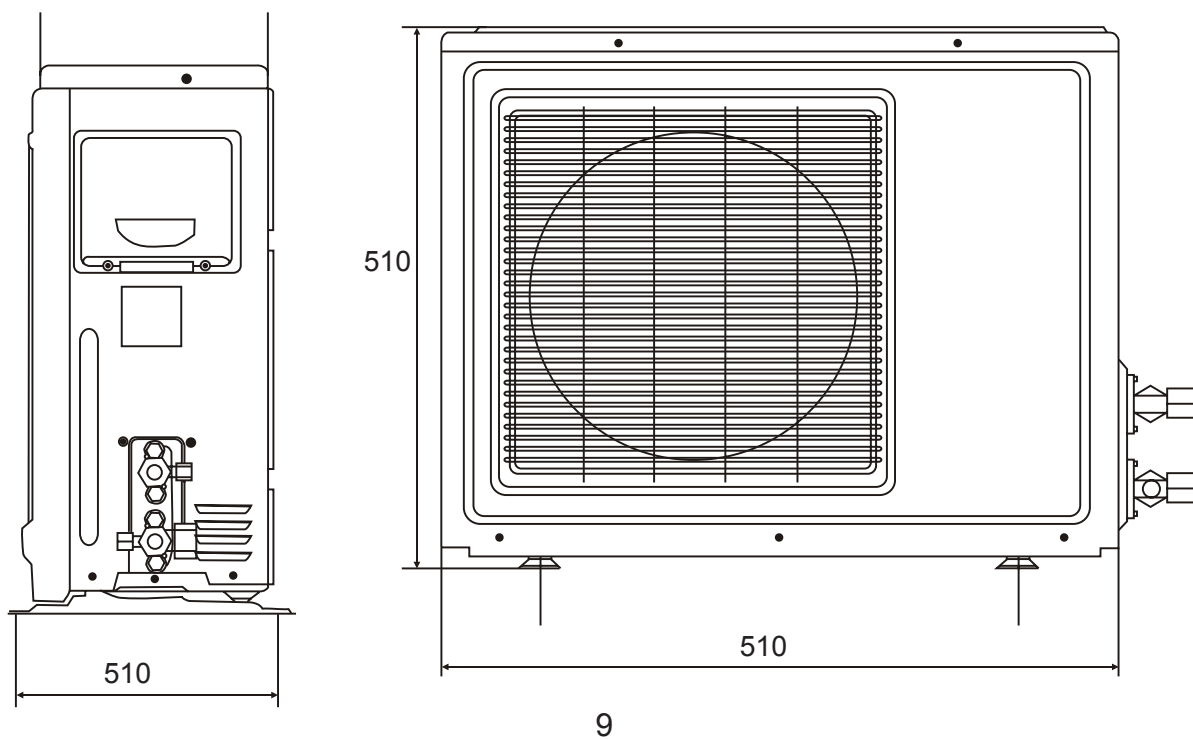

Brief introduction to electrical control function

1. Run mode:

1.1 automatic run mode

The tricolor indicator is white.

When the system runs under "automatic" mode for the first time, it will determine the operating mode according to the follows, ("Tr" stands for room temperature, and "Ts" for set temperature.)

$Tr \geq Ts+3$ Choose Cooling mode

$Tr < Ts-3$ Choose Fan Mode

The system will shift its operating mode between the above mentioned three to changes of the room temperature. If the system is currently under cooling mode, it will switch to fan mode when $Tr < Ts - 3$; if the system is currently under fan mode, it will in turn switch to cooling mode when $Tr > Ts + 3$. The switching mode as below:

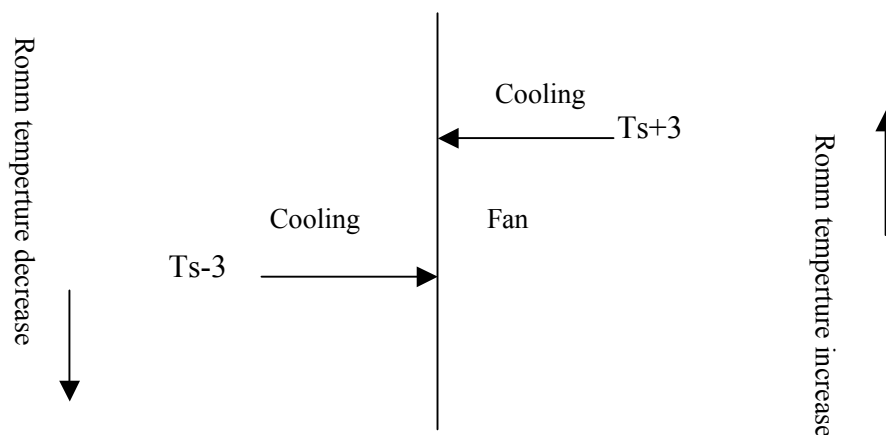

The indoor temperature is determined by the set temperature (accuracy: set temperature ± 1).

1.2 Cooling run mode:

* Tricolor indicator is blue.

*temperature control range : 16 —30

*temperature control precision: ± 1

*compressor can't be controlled by temperature sensor within 2minutes after it starts.

*control character: when Tr (inlet air) $\geq Ts$ (temperature setting), outlet air from compressor is on and indoor fan motor run at fixed wind speed. When Tr (inlet air) $< Ts$ (temperature setting), outlet air from compressor is off, and when $Tr > Ts$, outlet air from compressor is on.

*wind speed control:

auto: when $Tr \geq Ts+3$, the wind speed is high;

when $Ts+1 \leq Tr < Ts+3$, the wind speed is medium.

When $Tr < Ts+1$, the wind speed is low.

When temperature sensor is off, the fan motor runs at low speed.

Manual operation: When unit is on the wind speed can be set to high, medium, low or automatic as required

*compressor control : The compressor can't be controlled by temperature sensor within 2 minutes after startup and can be only restarted at least 3 minutes later after shutdown. There is no 3-minute protection with power on for the first time (over 3 minutes with power off). The compressor must stands by for 3 minutes before it is restarted after shutdown.

*There is no 2-minute limit when changing the temperature setting or shutting down the machine through the remote controller, and the machine can be shut down immediately.

* Avoiding electrical shock: outlet air is available 2 seconds later after startup.

*Controlling the position of air door: set the position of air door as required.

*Protection of temperature expiration is available: The compressor and outdoor fan motor will be shut down when the indoor temperature is above 72 °C and lasts 2 seconds. Only when 3 minutes pass by after shutdown and the temperature of coil pipe is below 64 °C, can the compressor be started, and indoor fan motor is controlled as the temperature sensor is off.

*Protection of expiration of current peak value is available: Current cross detection is available in order to avoid burning out the compressor when the current is too big. The action character as follows: The compressor can't be detected in 60 seconds after startup. when current is above 21A and lasts 3 seconds, the system enter protection mode and shut off compressor with outdoor air blower and indoor fan motor controlled as the temperature sensor is off. After 3 minutes the machine can be started again.

*Protection of frost is available (disable in test run or heating mode): In order to prevent the indoor heat exchanger from freezing (in refrigeration or dehumidifying mode), the compressor will be shut off when the temperature of the indoor coil pipe is or below 0 °C and the compressor runs for over 5 minutes. When the temperature of the indoor coil pipe ascends to over 7 °C, the compressor is restarted (must meet a 3-minutes delay)

*Timer on, Timer off and sleep control are available.

1.3 Dehumidifying mode: (the temperature difference is 1 °C)

* Tricolor indicator is watercolorful.

*Temperature control range : 16 °C —30 °C .

*Temperature control precision: ± 1 °C .

*control character:

- When T_r (indoor temperature) $> T_s$ (temperature setting) $+2$ °C, compressor and outdoor fan motor run continuously with indoor fan motor running in accordance with the wind speed setting.
- When T_r ranges from T_s to $T_s + 2$ °C, outlet air from compressor is on for 10 minutes and off for 6 minutes, the indoor fan motor is off in 3 minutes after shutdown of compressor and gives breeze in other time.
- When $T_r < T_s$, outlet air from compressor is unavailable, and the indoor fan motor enter breeze mode 3 minutes later after shut down of compressor.

*Wind speed control:

Automation: When $T_r \geq T_s + 5$ °C, the wind speed is high.

When $T_s + 3$ °C $\leq T_r < T_s + 5$ °C, the wind speed is medium.

When $T_s + 2$ °C $\leq T_r < T_s + 3$ °C, the wind speed is low.

When $T_s \leq T_r < T_s + 2$ °C, the machine gives breeze intermittently.

When $T_r < T_s$, there are 3 minutes to stand by before the indoor fan motor is shut off.

When $T_r < T_s$, there are 3 minutes to stand by before entering of breeze from outside.

Manual operation: When the temperature sensor is off or the indoor fan motor runs intermittently, the indoor fan motor can not be operated by hand (compelling automatic operation), along with the indoor fan motor can be operated in cooling mode. While controlling fan motor by hand in cooling mode, the cooling ranges include wind speed setting and refrigeration range, others are the same as fan motor in automation mode.

*compressor control : The compressor can't be controlled by temperature sensor in 2 minutes after

startup and also can't be started again at least 3 minutes later after shutdown. There are 3-minutes protection with power on for the first time (over 3 minutes with power off). The compressor must be started again 3 minutes later after shutdown.

*There is no 2-minutes limit when changing the temperature setting or shutting off the machine through the remote controller, and the machine can be shut down immediately.

*Avoiding electrical shock: outlet air is available 2 seconds later after startup.

*Controlling the position of air door: set the position of air door as required.

*Protection of temperature expiration is available: The compressor and outdoor fan motor will be shut down when the indoor temperature is above 72 °F and lasts 2 seconds. Only when 3 minutes pass by after shutdown and the temperature of coil pipe is below 64 °F, can the compressor be started, while indoor fan motor is controlled as the temperature sensor is off.

*Protection of frost is available : In order to prevent the indoor heat exchanger from freezing, the compressor will be shut off when the temperature of the indoor coil pipe is or below 0 °F and the compressor runs for over 5 minutes. When the temperature of the indoor coil pipe ascends to over 7 °F, the compressor is restarted (must meet a 3-minutes delay)

*Timer on, Timer off and sleep control are available.

1.3 Fan mode

* Tricolor indicator is yellow-green

* When the system runs under "fan" mode, compressor, 4-way valve and outdoor fan motor are off, the indoor fan motor running in accordance with the fan speed setting. high, medium and low speed is available.

2. Control function:

2.1 Timer function: You can set 24-hour timer on or timer off as required, and the minum time unit is 1 minute. After setting, the indicator of indoor unit is on, and it is off when timer setting is completed. There are several timer mode as follows.

- Timer on: Unit get off, when reaching time setting, unit starts. sleep setting is not allowed.
- Timer off: Unit runs. When reaching time setting, unit enters shutdown mode, and sleep function can be set. If timer off and sleep are set synchronously, the one which time is short run first. Executing shutdown instruction clear timer and sleep function.
- Timer on and timer off can be set synchronously.

2.2 Sleep function (saving function at night): the timer indicator lights up.

- In cooling/defrosting mode, the temp. setting increases 1 °F one hour later after startup. After another hour the temp. setting increase by more 1 °F and then run continuously for another 6 hours and then close.
- The fan speed is low when sleep function is set.

2.3 Emergency switch input:

- Press the switch of emergency operation, then buzzer rings once and unit enters the automatic operation mode. (emergency operation)
- If the switch is kept pressed for 5 seconds, buzzer ring two times and unit enter test run mode.
- Press the switch again, and then closes.
- The unit can receive remote control.
- Enter emergency operation from timer mode, then timer is cancelled.
- Test run:
 - 1) The temperature sensor of inlet air doesn't work, and compressor starts, high wind, the units runs cooling mode.

2) During test run:

- The prevention of freezing of evaporator doesn't work.
- Current cross control doesn't work.
- The control of current cross peak expiration doesn't work.
- Temperature control doesn't work.
- Temperature expiration control doesn't work.

2.4 The new function of air purifying:

When receiving the remote signal of air purifying after startup, the tricolor indicator is green. Once the fan motor starts, chip output a row of high level to drive the air purifying generation circuit, and purify air.

2.5 Memory function of work status : After power on and the unit is started, and then shut off the unit, the system should memory the run mode before shutdown..

3.express mode of malfunction:

Abnormal mode	Malfunction code
Indoor temp.sensitive resistance abnormal	E1
Indoor temp.sensor resistance of heat exchanging abnormal	E2
Communication of main-board and control-board abnormal	E8

WIRING DIAGRAM

CIRCUIT DIAGRAM

4. Principium diagram

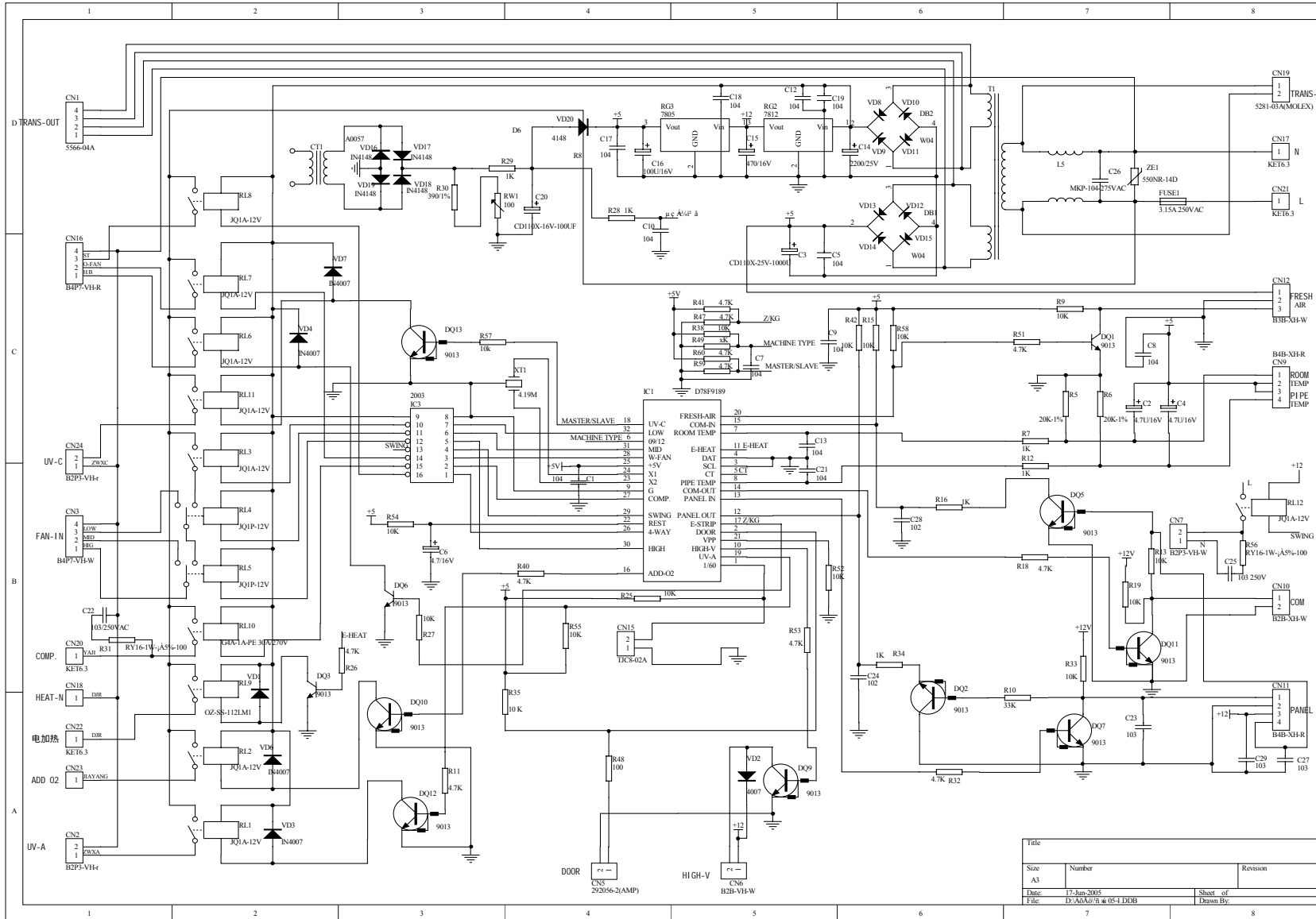

Все каталог и инструкции здесь: <https://>

Title		
Size	Number	Revision
A3		
Date:	17-Jun-2005	Sheet of
File:	D:\ACA\9\w 054.DDB	Drawn By:

Все каталоги и инструкции здесь: <https://splitsystema48.ru/instrukcii-po-ekspluatacii-kondicionerov.html>

ABNORMITY DIAGNOSE

Abnormality diagnosing

Все каталоги и инструкции здесь:

<https://splitsystema48.ru/instrukcii-po-ekspluatatsii-kondicionerov.html>

- a. The temperature sensor of coil pipe of indoor unit is in short circuit or broken circuit, the timing indicator of indoor unit is on, the power indicator is flickered in 1Hz;
- b. The room temperature sensor of indoor unit is in short circuit or broken circuit: the timing indicator of indoor unit is off, the power indicator is flickered in 1Hz;
- c. The motor of indoor unit has no backfeed of signal, the power indicator of indoor unit and running indicator are flickered twice, then the power indicator, running indicator and timing indicator are all flickered for 1 second, then repeating the cycle.





Все каталоги и инструкции здесь: <https://splitsystema48.ru/instrukcii-po-ekspluatacii-kondicionerov.html>

TROUBLE SHOOTING

Trouble shooting

Все каталоги и инструкции здесь: <https://splitsystema48.ru/instrukcii-po-ekspluatácii-kondicionerov.html>

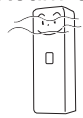
Before asking for service, check the following first.

	Phenomenon	Cause or check points
Normal Performance inspection	<p>The system does not restart immediately .</p> 	<ul style="list-style-type: none"> • When unit is stopped, it won't restart immediately until 3 minutes have elapsed to protect the system. • When the electric plug is pulled out and reinserted, the protection circuit will work for 3 minutes to protect the air conditioner .
	<p>Noise is heard:</p> 	<ul style="list-style-type: none"> • During unit operation or at stop, a swishing or gurgling noise may be heard. At first 2-3 minutes after unit start, this noise is more noticeable. (This noise is generated by refrigerant flowing in the system.) • During unit operation, a cracking noise may be heard. This noise is generated by the casing expanding or shrinking because of temperature changes. • Should there be a big noise from air flow in unit operation, air filter may be too dirty .
	<p>Smells are generated.</p>	<ul style="list-style-type: none"> • This is because the system circulates smells from the interior air such as the smell of furniture, cigarettes.
	<p>Mist or steam are blown out.</p> 	<ul style="list-style-type: none"> • During COOL or DRY operation, indoor unit may blow out mist. This is due to the sudden cooling of indoor air.
Multiple check	<p>Does not work at all.</p>	<ul style="list-style-type: none"> • Is power plug inserted? • Is there a power failure? • Is fuse blown out?
	<p>Poor cooling</p> 	<ul style="list-style-type: none"> • Is the air filter dirty? Normally it should be cleaned every 15 days. • Are there any obstacles before inlet and outlet? • Is temperature set correctly? • Are there some doors or windows left open? • Is there any direct sunlight through the window during the cooling operation?(Use curtain) • Are there too much heat sources or too many people in the room during cooling operation?

Все каталоги и инструкции здесь: <https://splitsystema48.ru/instrukcii-po-ekspluatacii-kondicionerov.html>

REFRIGERATING-CYCLE DIAGRAM

Refrigerating cycle diagram

Все каталоги и инструкции здесь: <https://splitsystema48.ru/instrukcii-po-ekspluatcii-kondicionerov.html>

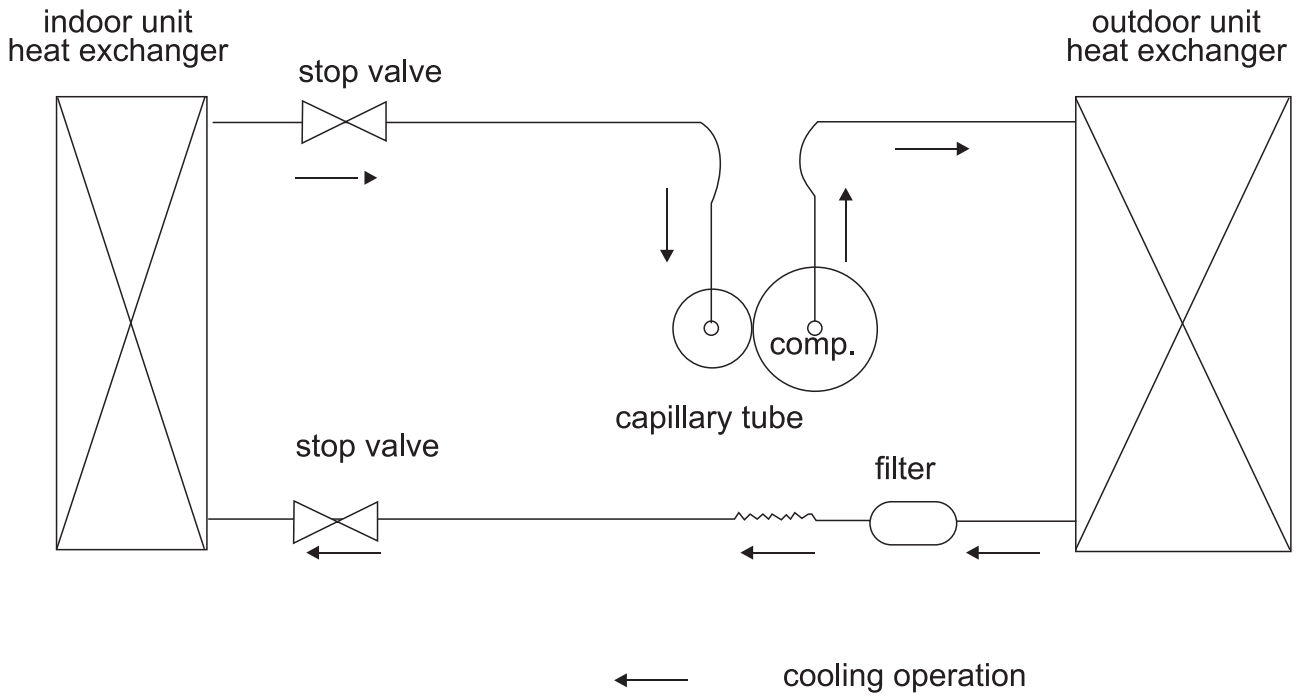

Все каталоги и инструкции здесь: <https://splitsystema48.ru/instrukcii-po-ekspluatacii-kondicionerov.html>

NOISE LEVEL TEST CHART & AIR VELOCITY DISTRIBUTION

A、 Noise level test chart

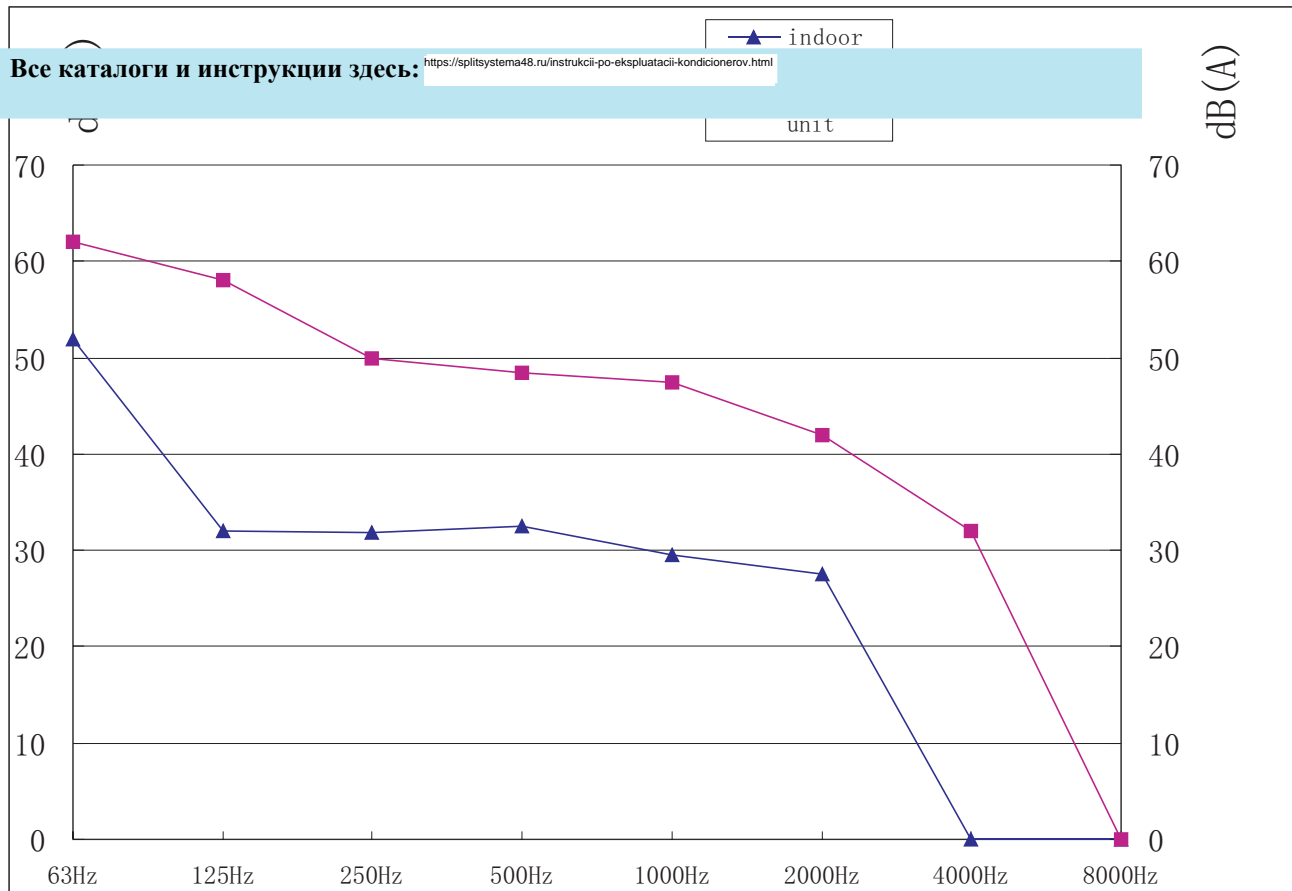

B. Air velocity distribution

Все каталоги и инструкции здесь: <https://splitsystema48.ru/instrukcii-po-ekspluatácii-kondicionerov.html>

Top View
Flow Control Panel: Horiz.
Louver: Center

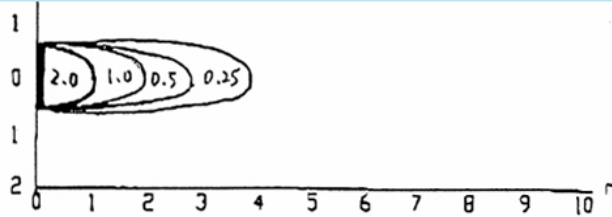

Fig 2
Top View
Flow Control Panel: Horiz.
Louver: right & left

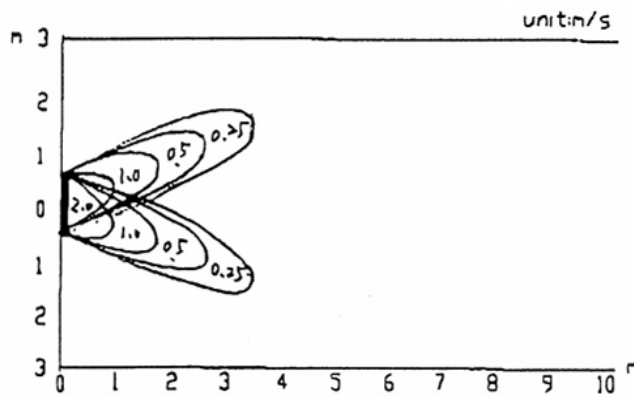

Fig 3
Side View
Flow Control Panel: Horiz.
Louver: Center

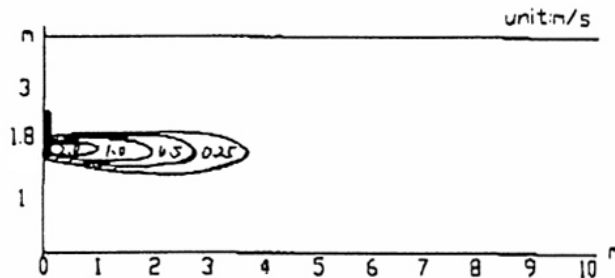
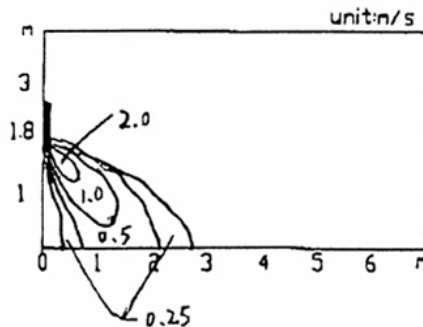

Fig 4
Side View
Flow Control Panel: Vert.
Louver: Center



Condition
Fan speed: high
Operation mode: Fan
Voltage : 230V
50Hz mode

Все каталоги и инструкции здесь: <https://splitsystema48.ru/instrukcii-po-ekspluatacii-kondicionerov.html>

Installation manual

Manual of Room Air Conditioner

Все каталоги и инструкции здесь: <https://splitsystema48.ru/instrukcii-po-ekspluatacii-kondicionerov.html>

Tool necessary

1. Screw driver
2. Hacksaw
3. 70mm dia.hole core drill
4. Spanner(dia. 17,27mm)
5. Spanner(14,17,19, 27mm)
6. Pipe cutter
7. Flaring tool
8. Knife
9. Nipper
10. Gas leakage detector
or soap water
11. Measuring tape
12. Reamer
13. Refrigerant oil

Standard accessories

Following parts shall be field supplied

Mark	Part name
Ⓐ	Adhesive tape
Ⓑ	Pipe clip
Ⓒ	Connecting hose
Ⓓ	Insulation material
Ⓔ	Putty
Ⓕ	Drain hose

No.	Shape and description	QTY
①	Remote controller	1
②	Cement nail	3
③	Connecting pipe	2
④	Drain hose	1
⑤	Wire clip	4
⑥	Insulation pipe	2
⑦	Wall hole cover	1
⑧	Piping hole cover	1
⑨	Dry battery #7	1
⑩	Rubber pad	4
⑪	Non-adhesive tape	1
⑫	signal hose	1

Fixing of the unit

1. Position of the wall hole

Wall hole should be decided according to installation place and piping direction.(refer to installation drawings).

2. Making a wall hole

Drill a hole of 70X70mm dia. with a little slope towards outside.

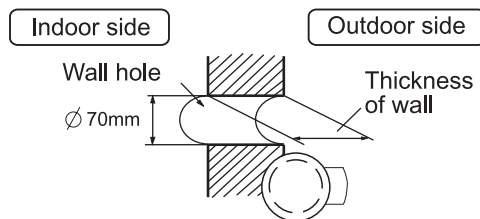

(Cross section of wall hole)

3. Piping connection

Connecting method

To bent a pipe, give the roundness as large as possible not to crash the pipe.

When connecting pipe, hold the pipe center to center then screw nut on by hand, refer to Fig.

Be careful not to let foreign matters, such as sands enter the pipe.

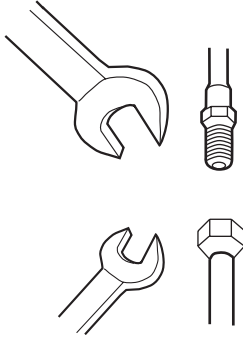

Forced fastening without careful centering may damage the threads and cause a leakage of gas.

Pipe Diameter (ϕ)	Fastening Torque
Liquid Side 6.35mm(1/4")	18N.m
Gas Side 12.7mm(1/2")	55N.m

Piping connection of the indoor unit

1. Arrangement of piping and drainage pipe

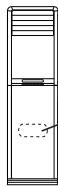

After opening inlet grill, you will see a control box as shown in the Fig.
Remove the cover before working.

Cut away, with a hammer or a saw, the lid for piping according to piping direction.

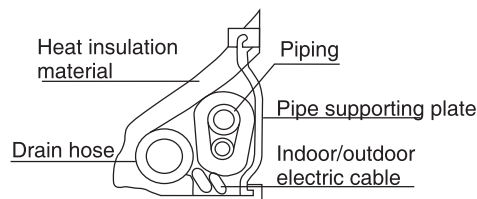

According to the piping method, connect the piping on indoor unit with union of connection pipe. Arrange the piping as per the wall hole and bind drain hose connecting electric cable and piping together with polyethylene tape.

Insert the bound piping connecting electric cable and drain hoses through wall hole to connect with outdoor unit.

2. Arrangement drain hose

Drain hose shall be placed in under place.

There should be a slope when arrange drain hose. Avoid up and down waves in drain hose.

If humidity is high, drain pipe(especially in room and indoor unit) must be covered with installation material.

Installation Manual of Room Air Conditioner

3. Piping connection of the outdoor unit
Connecting the connecting pipe and inlet and outlet liqued pipe according to the piping method.

Purging Method:

Push the air out of the indoor unit and piping as follows:

- (1) Remove the valve cap on 2-way valve in outdoor unit.
- (2) Loosen by 1/2 turn the flare nut of gas pipe, which is conneted to 3-way valve.
- (3) Loosen 2-way valve by 90o using hexagon wrench, and after approx. 6 sec tighten it up. Gas comes out through flare nut on wide pipe. If no gas is discharged, tighten flare nut with specified torque.
- (4) Open 2-way and 3-way valves using specified torque.
- (5) Tighten the caps on the valves with specified torque.

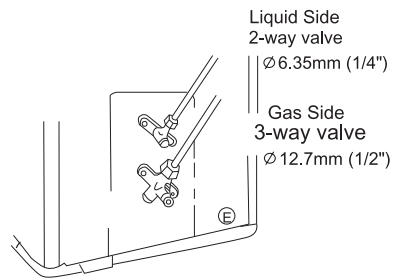

	Tighten torque N.m
Valve	7-9
Valve	20-25

Note: When additional refrigerant is necessary, first purge air out of connecting pipe by external gas, then drive out the excessive refrigerant by purging method.

Brand new unit is charged 80g more refrigerant than spec. This is only for first instalation to purge air in the indoor unit and connecting pipe.

Все каталоги и инструкции здесь: <https://splitsystema48.ru/instrukcii-po-ekspluatacii-kondicionerov.html>

When piping is longer than 5m, charge additional refrigerant specified in this list.

Pipe length	5m	10m	15m
Refrigerant charge(g)	————	90	180

Electric wiring

Note:

- Electric wiring must be done by qualified person.
- Use copper wire only.
- The parameter of the connecting cable is H07RN-F3X0.75mm²+2X0.75mm².

Wiring of indoor unit

- Insert the cable from outside the wall hole where piping already exist.
- Pull it out from front.
- Loosen terminal screw and insert cable end fully into terminal block, then tighten it
- Pull the cable gently to make sure it is tight.
- Replace cover after wiring.

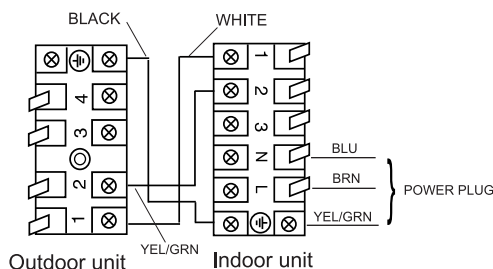
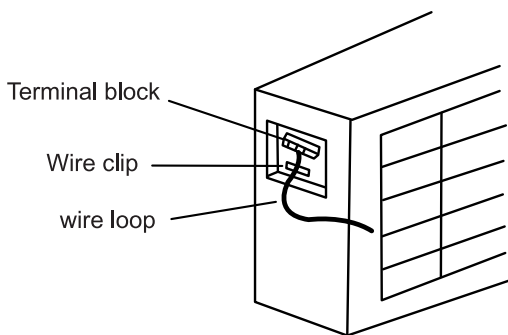
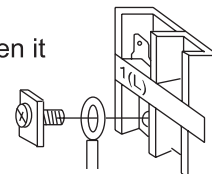
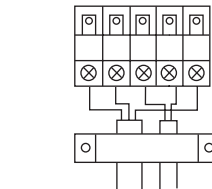

Note: User should prepare the part in the dashed frame by himself.

Wiring of outdoor unit

- Insert the cable from inside the wall hole where piping already exist.
- Pull it out from front.
- Loose terminal screw and insert cable end fully into terminal block, then tighten it
- Pull the cable gently to make sure it is tight.
- Replace cover after wiring.

Note:

- When connecting indoor and outdoor wire, check the number on indoor and outdoor terminal blocks. Terminals of same number and same color shall be connected by the same wire.
- Incorrect wiring may damage air conditioner's control or cause operation failure.

Все каталоги и инструкции здесь: <https://splitsystema48.ru/instrukcii-po-ekspluatatsii-kondicionerov.html>

Installation Manual of Room Air Cond

Others

1. Power supply

Air conditioner must use an exclusive line(over 30A) and there is not power p the type of power supply wire is H05VV-F3G4.0mm².

When installation air conditoner in a wet place, try to use a circuit breaker ag leakage.

For installation in other palces, use circuit breaker as far as possible.

2. Piping cutting and flaring

Be sure to carry out deburring after cutting with a pipe cutter.

Insert flaring tool to make a flare.

lug with this type,

ainst Current

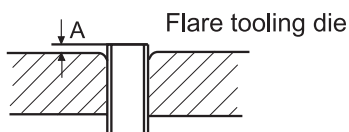

	Pipe diameter ϕ	Size A (mm)
Liquid pipe	9.52mm(3/8")	0.8 ~1.5
Gas pipe	15.88mm(5/8")	1.2 ~2.0

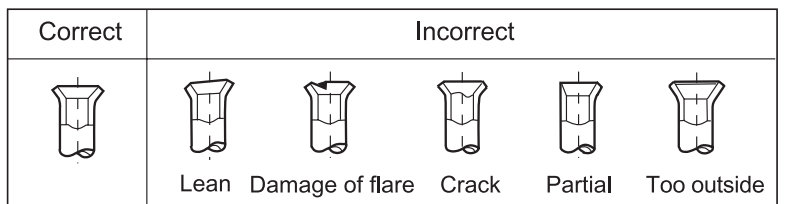

Installation inspection and test run:

Please operate unit according to this Manual.

Items to be checked during test run. Please made a "✓" in "□"

- Are there any gas leakage?
- How is insulation at piping connection carried out?
- Are electric wires of indoor and outdoor unit firmly inserted into terminal block?
- Is electric wiring of indoor and outdoor securely fixed?
- Is drainage securely carried out?
- Is earth line(grounding) securely connected?
- Is power supply voltage abided by the code?
- Is there any noise?
- Is control display normal?
- Is cooling operation normal?
- Is room temp. regulator normal?

Sincere Forever

Haier Group

Haier Industrial Park, No.1, Haier Road

266101, Qingdao, China

<http://www.haier.com>



Большая библиотека технической документации

<https://splitsystema48.ru/instrukcii-po-ekspluatácii-kondicionerov.html>

каталоги, инструкции, сервисные мануалы, схемы.